



Easy Radio 868,35 MHz

CHRONOTHERMOSTAT WITH RADIO TRANSMISSION



Chronothermostat
Easy Radio



Receiver

Code	Description	Power supply
3.557.2147	Transmitter	Two 1.5V AA batteries
3.557.2148	1-channel receiver	230Vac-50Hz
3.557.2151	1-channel receiver	
3.557.2152	1-channel receiver	
3.557.2153	1-channel receiver	

WARNINGS

The unit must be installed and decommissioned by specialist technical personnel.

The device must be installed in compliance with the domestic laws in force.

Check that the terminals are not live before proceeding with installation.

The use of a radio transmission device (GSM) can cause interference with devices that do not have radiofrequency shielding.

THE CHRONOTHERMOSTAT

Easy Radio is a daily and weekly electronic chronothermostat that allows you to program the temperature in your home for every hour and every day of the week.

Easy Radio has a backlit screen for viewing the programmed temperatures, and simple and functional controls for user-friendly programming.

Easy Radio saves on energy by activating the heating or air-conditioning system only when necessary.

Easy Radio is an electronic chronothermostat with a **RADIO TRANSMITTER**, meaning it does not require an electrical connection to the boiler.

Easy Radio is powered by two ordinary 1.5V AA alkaline batteries that guarantee use for at least 2 years.

To insert the batteries, slide off the BATTERY COVER and put the batteries in the right way. **Easy Radio** has two battery power thresholds. When the first threshold is reached, the **BAT** symbol (Fig. 9) appears on the screen while the unit continues to work normally. When the second threshold is reached, **Easy Radio** disables all its heat regulation functions, and the time, date and low battery symbol (**BAT**) blink on the screen.

The unit can retain the data for 30 seconds without power while you replace the batteries.

To program the **Easy Radio** chronothermostat, please read the section "**OPERATION AND PROGRAMMING**".

FUNCTIONS OF THE RECEIVER/RADIO BRIDGE

The **JP1** jumper setting allows the RECEIVER to work in several modes.

- 1 - **Receiver** mode (A-B) (E-F)
- 2 - **Repeater** mode (A-B) (D-E)

1 - RECEIVER MODE

Position the **JP1** jumpers as shown in Fig. 1.

In this way, the unit works as a receiver, activating or deactivating the load to be controlled.

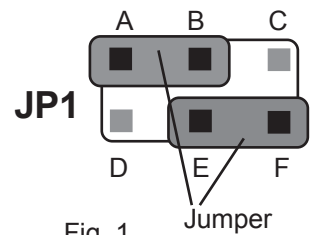

Fig. 1

2 - REPEATER (BRIDGE)

Position the **JP1** jumpers as shown in Fig. 2.

This is used when:

- The distance between the TRANSMITTER and the RECEIVER is more than 100 metres, potentially causing loss of the *radio signal*;
- Transmission of the *radio signal* is weak due to interference.

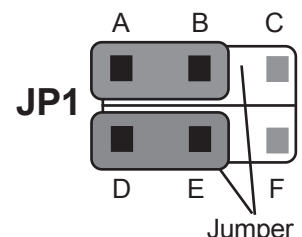

Fig. 2

A REPEATER is installed to prevent loss of the radio signal between the TRANSMITTER and the RECEIVER.

EMERGENCY MODE

The **Easy Radio** chronothermostat sends a test signal to the **RECEIVER** once every 20 minutes. The **RECEIVER** enters EMERGENCY mode if it does not receive a signal within a period of 30 minutes. EMERGENCY mode has three settings: Comfort, Antifreeze and OFF. The JP2 JUMPER is set to configure:

- 1 - **Comfort mode (H-I) (M-N)**
- 2 - **Antifreeze mode**
- 3 - **OFF mode**

1 - Comfort

Position the **JP2** jumpers as shown in Fig. 3. In this way, the **RECEIVER** activates the load 15 minutes ON and 15 minutes OFF until radio communication is re-established.

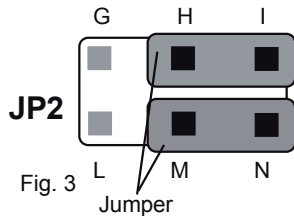

2 - Antifreeze

Position the **JP2** jumpers as shown in Fig. 4. In this way, the **RECEIVER** always activates the load for 15 minutes every 4 hours.

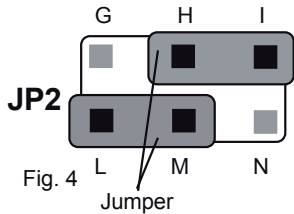

3 - OFF

Position the **JP2** jumpers as shown in Fig. 5. In this way, the **RECEIVER** always keeps the load in OFF mode.

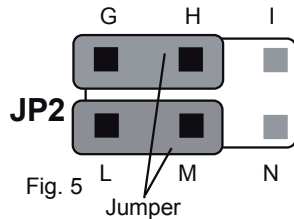

If you attempt to access **MANUAL** mode when the unit is in **EMERGENCY** mode, the **RECEIVER** exits **EMERGENCY** mode and switches the relay to manual mode and no longer to automatic mode. **MANUAL** mode is deactivated only when the unit receives a *radio signal* from the **TRANSMITTER**.

POWER SUPPLY OF THE CHRONOTHERMOSTAT

Easy Radio is powered by two ordinary 1.5V AA type alkaline batteries that guarantee use for at least 2 years. To insert the batteries, slide off the **BATTERY COVER** and put the batteries in the right way. (Fig. 6)

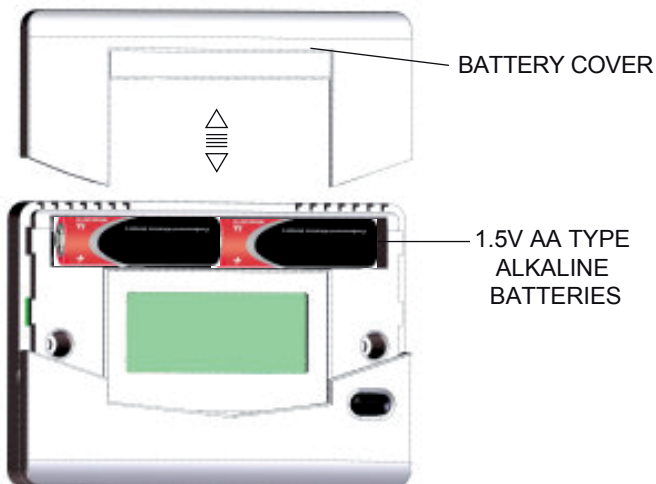

POWER SUPPLY OF THE RECEIVER/RADIO BRIDGE

- 1 - **Check that the conductor heads are not live.**
- 2 - Fasten the base of the **RECEIVER** near the load to be controlled using the screws provided (Fig. 7).
- 3 - Insert the wires in the relative cable gland.
- 4 - Connect the 230Vac terminals to a 230Vac-50Hz power supply (Fig.8).

Interposed in series to the phase a protection fusible of 250mA N.B. When the **RECEIVER** is powered from the mains, the two LEDs on the front blink for a few moments and then turn off.

A simply accessible device must be incorporated outside to the equipment. **WARNING** : Use cables with double insulation and make sure that you do not touch the low voltage circuit areas .



In the event that you were using the cable supplied from us cables must not be accessible outside of the product, otherwise replace the cable supplied with an industry cables.

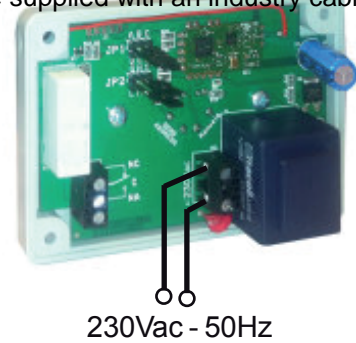
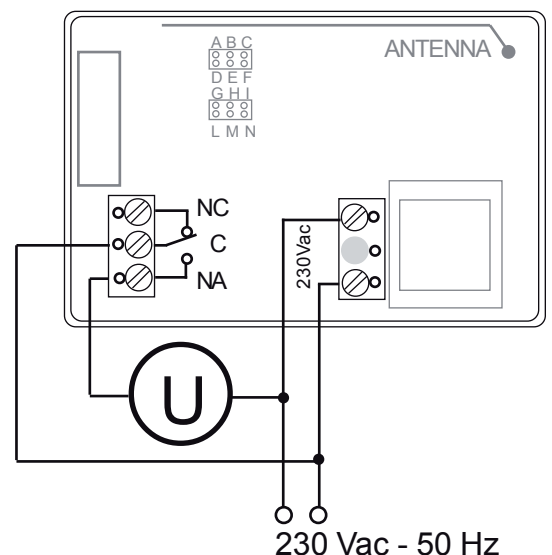

Fig.8 The back as seen from the front

LOAD CONNECTION DIAGRAMS

The diagrams below indicate how to connect the **RECEIVER** to the load to be controlled. Connection to the burner, the wall-mounted boiler, the air-conditioning system, and the spring return zone valve (Fig. 9).



Connection to the zone valve (Fig. 10).

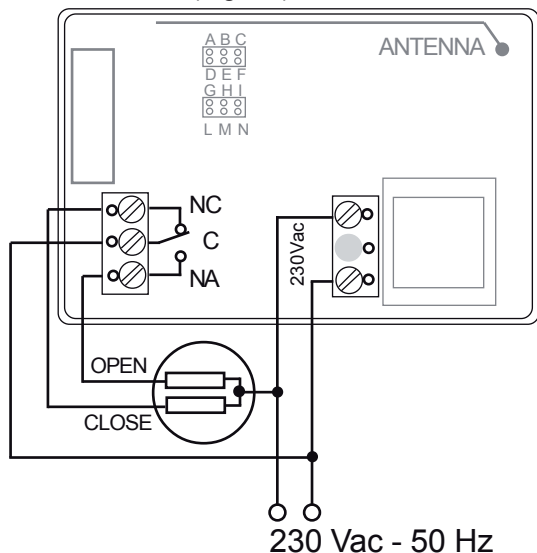

Fig.10

N.B. Before powering the unit, check that it is correctly connected to the power supply and to the load to be controlled.

GENERAL DESCRIPTION

In order for the **Easy Radio** to work properly, it has to “teach” its code to the **RECEIVER**. The **RECEIVER**, connected to the device to be controlled (boiler, valve, pump or air conditioning system), “learns” the code received and converts the **TRANSMITTER**’s wireless ON/OFF signal into commands for the controlled device. The **RECEIVER** can also act as a **BRIDGE** when the distance between the **TRANSMITTER** and the **RECEIVER** prevents the radio signal from reaching its destination.

COUPLING THE TRANSMITTER/RECEIVER SIGNAL



TRANSMITTER



RECEIVER
JP1: (A-B) e (E-F)

PROCEDURE:

Check that the unit is connected to the mains and then follow these instructions:

1 Press and hold, for about 3 seconds, the **ON** button at the back of the **TRANSMITTER** (Fig.11), until the RED LED illuminates and remains steady.

2 Press, for 1 second, the **teach-in** button **F2** on the front of the **RECEIVER**.

The GREEN LED  blinks for a few moments. (The LED blinks to indicate that coupling has been completed successfully). The GREEN LED on the **RECEIVER** illuminates depending on the *quality of the signal*, and the RED LED of the **TRANSMITTER** turns off after a few seconds.

Led

Fig.11

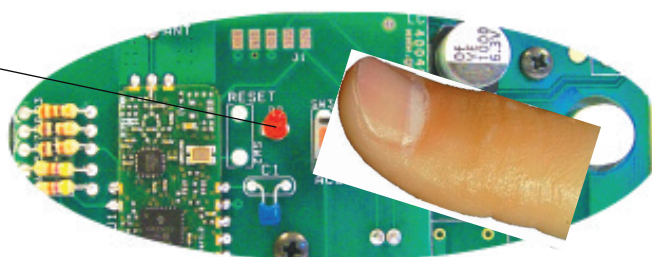

N.B. The GREEN LED on the RECEIVER does not turn on if coupling is unsuccessful. At this point, repeat steps 1 and 2 of the procedure.

COUPLING OF SIGNAL BETWEEN TRANSMITTER and BRIDGE and between BRIDGE and RECEIVER.



TRANSMITTER



BRIDGE
JP1: (A-B) e (D-E)

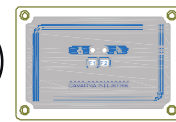

RECEIVER
JP1: (A-B) e (E-F)

A maximum of two **BRIDGES** can be installed between the **TRANSMITTER** and the **RECEIVER**.

PROCEDURE:

Check that the unit is connected to the mains and then follow these instructions:

1 Press and hold, for about 3 seconds, the **ON** button at the back of the **TRANSMITTER** (Fig.11), until the RED LED illuminates and remains steady.

2 Press, for about 1 second, the **F2** button on the front of the **BRIDGE**.
(The **TRANSMITTER** and the **BRIDGE** are coupled).

The RED LED on the **TRANSMITTER** remains steady for about 10 seconds.

3 When the RED LED on the **TRANSMITTER** turns off, press and hold the **F1** button on the **BRIDGE** until the GREEN LED  illuminates.

4 Press the **F2** button on the **RECEIVER**.
(The **RECEIVER** and the **BRIDGE** are coupled).

The GREEN LED on the **BRIDGE** remains steady for 10 seconds.

N.B. The procedure for coupling the **BRIDGE** and **RECEIVER** is the same for coupling one **BRIDGE** to another.

RESENDING THE SIGNAL

The **TRANSMITTER** sends the ON or OFF signal to the **RECEIVER** not just once but up to three times within a period of 5 seconds.

The transmitter then repeats this operation, sending the latest signal to the **RECEIVER** every 20 minutes.

The purpose of this is to update the **TRANSMITTER** with the **RECEIVER/BRIDGE** to ensure that the status of the **TRANSMITTER** is not lost in the event of a power cut.

MANUAL LOAD FUNCTION

Press the **F1** button for 3 seconds to manually activate or deactivate the relay of the **RECEIVER**.

The unit exits **MANUAL** mode when the **TRANSMITTER** sends the first *Radio signal*.

RADIO COVER

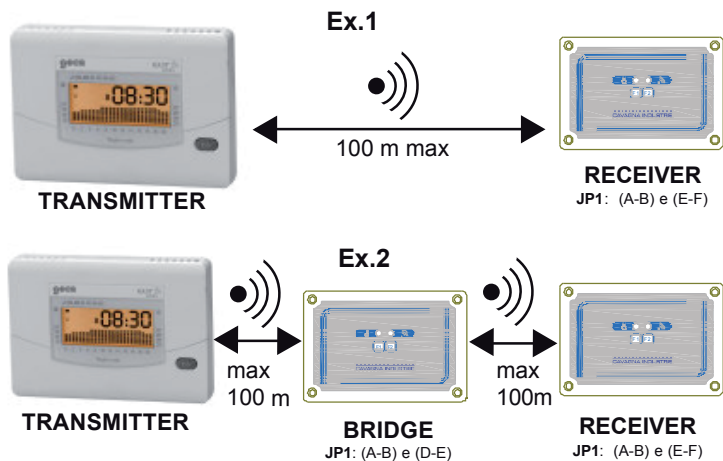

THE CHRONOTHERMOSTAT

INSTALLATION OF THE CHRONOTHERMOSTAT

Easy Radio can be installed directly on a recessed 3-module box (semi-recessed installation), Fig. 12, or on the wall, Fig. 13. In both cases, it is advisable to install the unit 1.5 m above floor level, in a dry area away from draughts and sources of heat.

SEMI-RECESSED INSTALLATION

WARNING: DO NOT TIGHTEN THE SCREWS TOO TIGHTLY BECAUSE THIS COULD DAMAGE THE FRONT.

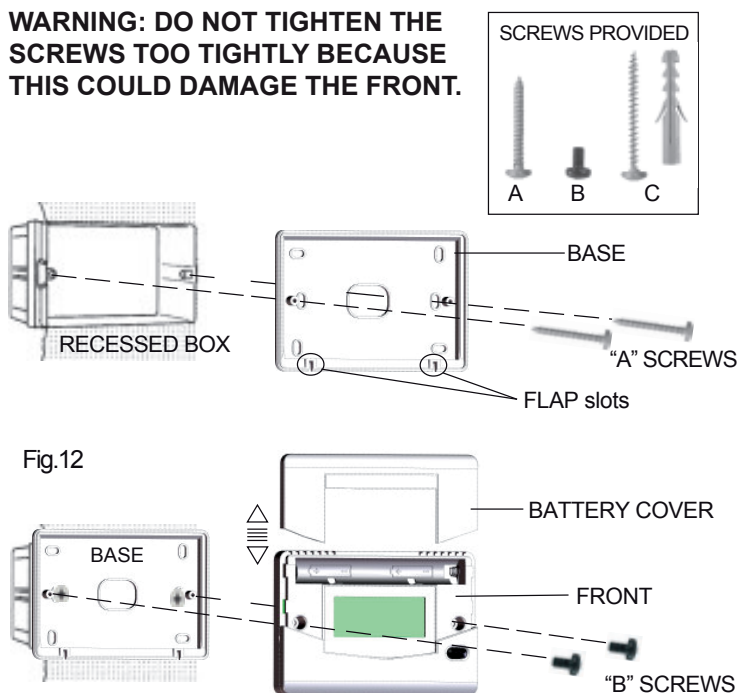

Fig.12

WALL INSTALLATION

After attaching the BASE to the wall (with the FLAP slots at the bottom) using the type "C" screws and wall plugs provided, connect the chronothermostat to the mains supply and attach it to the BASE with the "type B" screws. Lower the BATTERY COVER to complete installation.

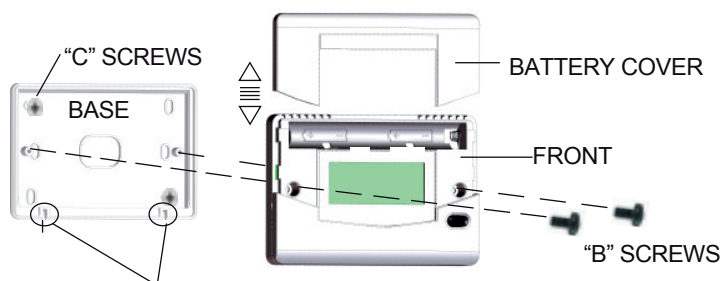

Fig.13 FLAP slots

INITIALISATION

Power the **Easy Radio** and run a test cycle, turning on all the segments of the display and activating the load for a few seconds.

If there is a risk that initialisation could compromise correct operation of the load, power the chronothermostat before making the electrical connections.

OPERATION AND PROGRAMMING

An important feature of the chronothermostat is the backlit graphical display which shows 24 columns representing the hours of the day; the height of each column indicates the temperature programmed for that hour.

The top-left segment (A in Fig. 14), below the printed text, indicates the date of the programme.

The programmed temperature (B in Fig. 14) is shown in the top right-hand corner during the programming phase, and is identified by the blinking date and "C" symbol indicating the temperature in °C.

Pressing the °C/h button (Fig.14) during normal operation displays the date and ambient temperature in alternation.

Once powered, **Easy Radio** shows a standard diagram for use and the clock starts at 00.00 on Monday (MON). To edit the standard programme, select the required day by pressing the DAY button (Fig. 14) and change the daily graph using the four central buttons arranged in a cross.

The +h and -h buttons (Fig. 14) move the cursor horizontally along the TIME axis and the +°C and -°C buttons (Fig.14) edit the temperature.

Use the four buttons, +h, -h, +°C and -°C, and the DAY button, to edit the weekly temperature programme at any time.

The minimum temperature increment or decrement set with the +°C and -°C buttons is 0.1°C. The increment or decrement becomes 0.2°C, however, if you press and hold the +°C or -°C button.

After programming the first day, you can programme the others in either of two ways:

- Press the DAY button (F in Fig. 14) to move to the next day and view the saved programme (if one is not available, the standard graph is displayed) which you can edit as described previously.

- Use the COPY function to copy the day you have just programmed for the following day.

ACTIVE LOAD

The load is active when the flame symbol "🔥" appears on the display of the **Easy Radio** chronothermostat and the RED LED 🔴 on the RECEIVER is illuminated.

COPY BUTTON:

In order to copy the programme of the day you have just programmed for other days, press and hold the COPY button for two seconds.

The word COPY appears on the display and the cursor blinks on the day for which you want to copy the programme.

Use the **+h** or **-h** buttons to scroll through the days of the week and press the COPY button to confirm the day for which you want to copy the programme.

To exit the COPY function, simply wait a few seconds without pressing any of the buttons.

After programming the entire week, you need to update the time and date by pressing the SET button with a pointed tool. (Fig.14).

SET BUTTON:

Use the SET button to update the HOUR, MINUTES and DATE. The HOUR starts blinking when you press the SET button.

Use the **+°C** and **-°C** buttons to set the current TIME. Press the +h button to move to the MINUTES, which will start blinking. Use the **+°C** and **-°C** buttons to set the MINUTES.

Press the +h button to move to the DAY, which will start blinking. Use the **+°C** and **-°C** buttons to set the DAY.

The **Easy Radio** is now ready for normal operation, and the flame symbol will appear on the display (Fig. 14) whenever a load (heating or air-conditioning) is activated.

MANUAL OPERATION

Press the AUT/MAN (Fig. 14) to select manual mode. The graph (still saved in the memory) is replaced by the "hand" symbol (Fig. 14).

The **Easy Radio** now acts as a simple ambient thermostat and you can set the temperature with the **+°C** and **-°C** buttons (O, P in Fig.14). The set temperature, shown on the display, is maintained until you exit manual mode by pressing the AUT/MAN again (to enter automatic mode).

OFF BUTTON

Press the  button (R in Fig.14) for two seconds to turn off the chronothermostat. The **Easy Radio** deactivates the functions of the set programmes (still saved in the memory) and displays, in alternation, the word OFF and the current time or temperature reading.

Press the **°C/h** button if you want to view the TIME instead of the temperature.

The ANTIFREEZE FUNCTION remains active when the chronothermostat is off. If the ambient temperature falls below **7 °C** ($7^{\circ}\text{C} - 0.2^{\circ}\text{C} = 6.8^{\circ}\text{C}$), the unit activates the system to keep circulating the water, preventing it from freezing in the pipes.

PROGRAMME RESET FUNCTION

If you need to cancel a programme you have entered (e.g. after a programming test), press the **AUT/MAN** and **COPY** buttons (T and H in Fig. 14) at the same time for about two seconds; **Easy Radio** restarts initialisation as described previously.

QUALITY OF THE RADIO SIGNAL

The GREEN LED  on the RECEIVER indicates the **QUALITY** of the **RADIO SIGNAL** for two minutes whenever the receiver receives a radio signal from the TRANSMITTER.

The **GREEN LED**  on the RECEIVER / BRIDGE remains steady or blinks for about 2 minutes, depending on the **QUALITY** of the **RADIO SIGNAL** received.

The **QUALITY** of the **RADIO SIGNAL** varies according to the distance between the **TRANSMITTER** and the **BRIDGE/RECEIVER** and the degree of interference.

- **Steady GREEN LED:** The **QUALITY** of the signal is EXCELLENT (distance of 0-40m).

- **Fast blinking GREEN LED:** The **QUALITY** of the signal is GOOD (distance of 0-65m).

- **Slow blinking GREEN LED:** The **QUALITY** of the signal is SUFFICIENT (distance of 0-85m)

- **GREEN LED off:** The **QUALITY** of the signal is INSUFFICIENT (distance of more than 100m).

BARRIERS

The quality of the *Radio signal* received by the **RECEIVER** varies according to the nature of the walls.

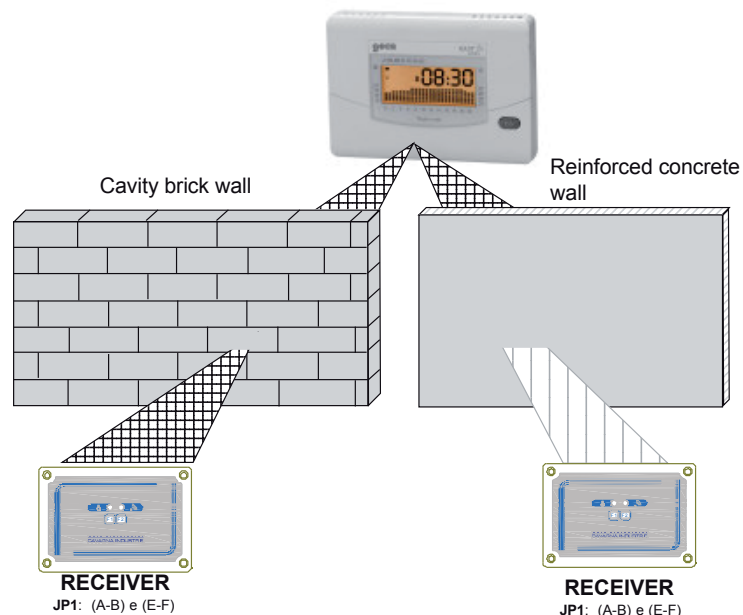

TERMS OF THE GUARANTEE

THIS CERTIFICATE IS THE SOLE DOCUMENT ENTITLING THE USER TO REPAIR OF THE PRODUCT UNDER THE TERMS OF THE GUARANTEE

- The **GUARANTEE** is valid for a period of 24 months from the date of purchase.

- The **GUARANTEE** does not cover damage attributable to tampering and incorrect or improper use and installation.

- The **GUARANTEE** is valid only when it has been duly filled in.

- In the case of defects covered by the **GUARANTEE**, the manufacturer shall repair or replace the product free of charge.

AFTER THE GUARANTEE PERIOD:

When the **GUARANTEE** expires, the user is billed for the cost of replacements and manual labour.

CHRONOTHERMOSTAT/TRANSMITTER

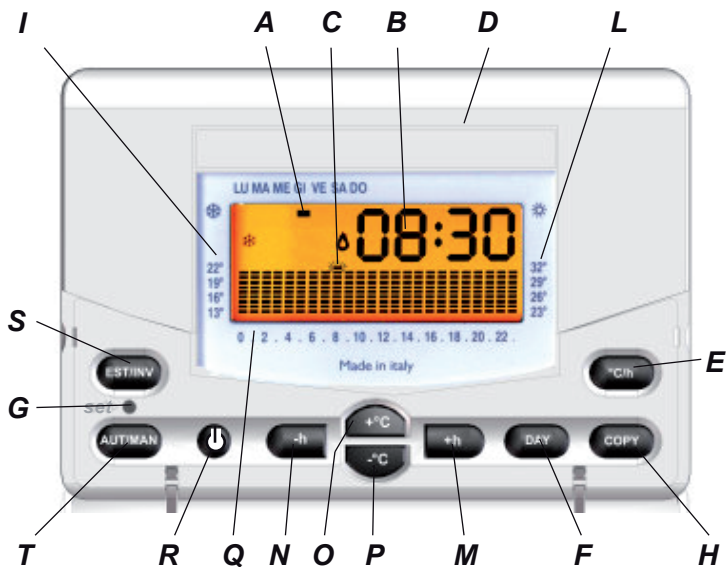







Fig.14

-  WINTER operating mode symbol
-  SUMMER operating mode symbol
-  MANUAL operating mode symbol
-  Low battery symbol
-  Relay contact closed symbol

A segment indicating the current day or, during programming, the programmed day.

B numerical display indicating the current time or ambient temperature, viewed in alternation by pressing button **E**. Indicates the temperature during programming.

C blinking segment; indicates the external temperature or, during programming, the programmed temperature.

D Battery cover.

E button for viewing, in alternation, the current time and ambient temperature. Press also to exit programming mode.

F button for scrolling through the days during programming.

G recessed button for setting the HOUR, MINUTES and DAY.

H button for copying the programme of the day shown for other days of the week.

I temperature scale for operation in WINTER (**WIN**) mode

L temperature scale for operation in SUMMER (**SUM**) mode.

M button for increasing the HOUR during programming.

N button for decreasing the HOUR during programming..

O button for increasing the temperature during programming.

P button for decreasing the temperature during programming.

Q scale of hours during the day.

R ON / OFF button.

S button for selecting the WINTER (**WIN**) - SUMMER (**SUM**) season programme.

T button for selecting the automatic (**AUT**) or manual (**MAN**) programme.

RECEIVER

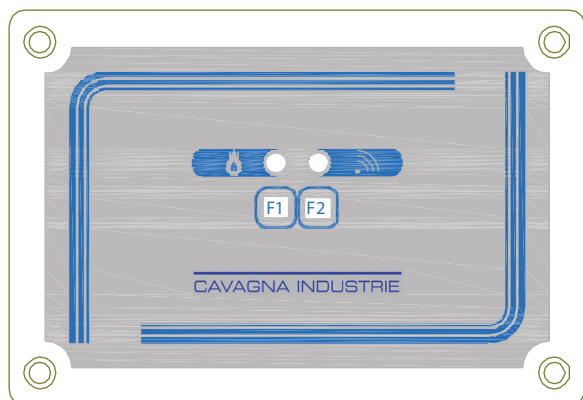

 RED LED indicating load status:
RED LED steady: **LOAD ON**
RED LED off: **LOAD OFF**

 GREEN LED indicating:
1- The **QUALITY OF THE SIGNAL**
2- Successful coupling.

 **F1** Button for setting **MANUAL MODE**.

 **F2** Button for coupling the **TRANSMITTER** and the **RECEIVER/BRIDGE**.

Dis.1034120A



GECA Srl via E. Fermi n°98 25064 Gussago (BS) Italy
Tel. +39 030 3730218 - Fax +39 030 3730228 -
www.cavagnaindustrie.com - info@gecasrl.it

GECA s.r.l. reserves the right to make aesthetic or functional changes without notice and at any time.

